

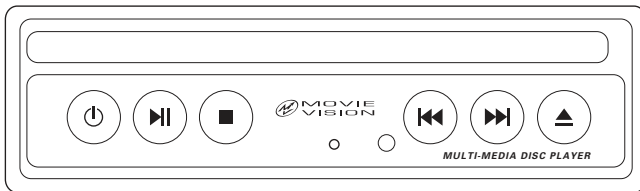

Owner's Manual

Mobile DVD Player



Model: MV-DVD-PL7

For operational or technical assistance, after reading this manual,
please call us toll free at (800) 638-3600.

Contents

Features	1
Caution	1
Precautions	1
Functional Introduction To The Front Panel	2
Functional Introduction To The Remote Control	3
System Setup	4
Basic Operation For Player Of DVD	7
Basic TV Operations	8
Other Operations	9
Real panel and Accessories	10
Specification	11

Features

- Compatible to DVD/CD/SVCD/VCD/MP3
- Electronic and Mechanical Anti-shock
- Slot-In Four-Speed DVD Loader
- Rear RCA Outputs
- 20Hz-20kHz Outputs
- 12V Input
- Remote Sensor
- Multi Angle/Language/Subtitle
- Last Memory

Caution

In order to avoid the player from any damage, please abide by following precautions:

- Make sure the grounding wire of the Player is the negative pole of its DC 12 V power supply.
- Never open the top or bottom of the Player without permission.
- Never install this Player under places under direct sunshine, too hot or too humid. Try to avoid installation at places with too much dust or exposure to water drops.
- Any change of fuse is only limited to those at power rating.
- Application of error fuse may cause function failure to the Player.
- When change the fuse, please power off the Player at first.
- In order to avoid any damage to the player, please never place 3 inch disc.

Precautions

Condensation caused by moisture may happen to the lens inside the product, it will affect the play effect in such case. Please turn off the power (unload the disc) to operate it 1-2 hours, Vaporize the condensation with the home-grown heat.

- Handle the disc by its edge to keep the disc clean, and do not touch the surface.

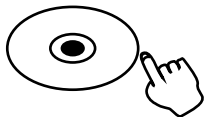

- Do not use disc with labels or stickers attached.



- Never keep the laser disc at places under direct sunshine, with high temperature or humidity. Place the disc into the packing box and keep inverted storage. Slanted or stacked storage may damage laser disc and cannot be played.

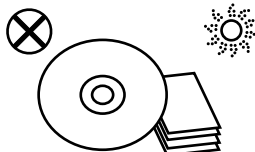

- Clean the discs with dry Cleaning cloth. Wipe each disc from the center out.

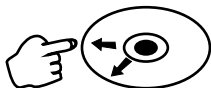

Front Panel Buttons & Function

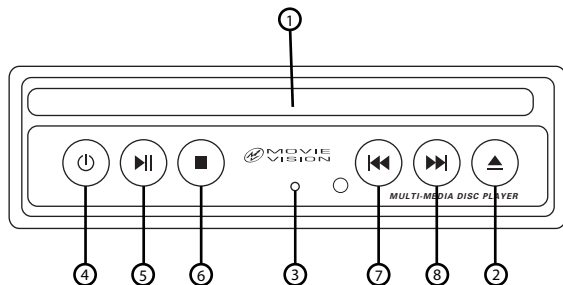

- ① Disc Insert Slot
- ② Eject
- ③ LED
- ④ Power
- ⑤ Play/Pause
- ⑥ Stop
- ⑦ Previous
- ⑧ Next

Remote Control Buttons & Function

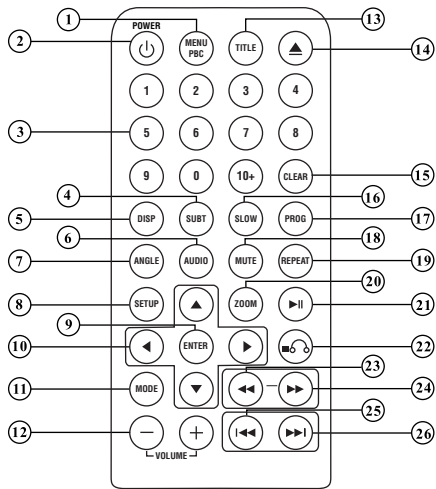

- | | |
|---------------|--------------|
| ① MENU PCB | ⑭ EJECT |
| ② POWER | ⑮ CLEAR |
| ③ NUMBER | ⑯ SLOW |
| ④ SUBTITLE | ⑰ PROGRAM |
| ⑤ DISPLAY | ⑱ MUTE |
| ⑥ AUDIO | ⑲ REPEAT |
| ⑦ ANGLE | ⑳ ZOOM |
| ⑧ SETUP | ㉑ PLAY/PAUSE |
| ⑨ ENTER | ㉒ STOP |
| ⑩ CURSOR KEYS | ㉓ BACKWARD |
| ⑪ MODE | ㉔ FORWARD |
| ⑫ VOLUME | ㉕ PREVIOUS |
| ⑬ TITLE | ㉖ NEXT |

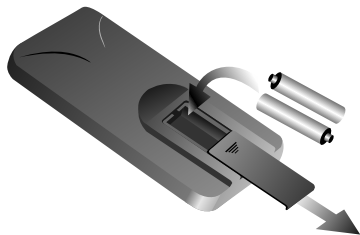

Loading batteries for IR remote control

Slide open battery door. Insert two "AAA" size batteries according to polarity marks "+" and "-" shown in the battery compartment. (Please point the remote control IR towards the front panel of the player to get the best response).

System Setup

Press [SETUP] button, the SETUP menu is displayed, select the preferred item by using the [◀] [▶] buttons. Press [ENTER] button. In the submenu, using the [▲] [▼] button to select. When some item be selected, press [ENTER] to enter this submenu, press [▲] [▼] to select, press [ENTER] button to confirm what you need item, at the same time the item will be highlighted.

Press [◀] to exit submenu and can executing other item. Press [SETUP] can exit system setup menu.

1. General Setup Page

(1) Setup TV Display Mode

- A. Select Normal / PS, Screen will display full picture, but it will loose some picture in the all sides.
- B. Select Normal / LB, Screen will display full picture, no any parts of it will be lost.
- C. Select Wide, Screen will display full picture, but it will loose some picture in the life and right sides.

(2) Setup Angel Mark

DVD Disc can record several screens which is recorded by different camera from different angel, user can prefer one of it to play.

On: Angel Mark on

Off: Angel Mark off

Note : Setup angel mark will available when disc with multi-angel mark.

(3) Set OSD language

User can select setup menu and display language on the screen.

English : All operations display English

Spanish: All Operations display Spanish

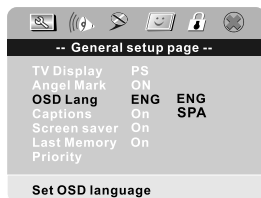
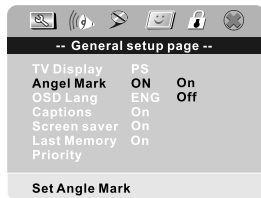
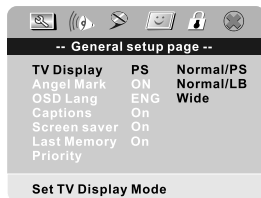

(4) Set Captions

On : Captions On

Off : Captions Off

Notes : It will available when the Disc with this function.

(5) Set Screen Saver

After stop play for period of time or no any disc in the machine, the Screen Saver will start. When Screen Saver function, the screen will display black background and with a DVD Mark moving on the screen.

This function can save the screen lift-time.

On: Screen Saver On

Off: Screen Saver Off

(6) Set Last Memory

This function is to remember the position at last Play. It needs 3 seconds to function after power off.

On : Last Memory On

Off : Last memory Off

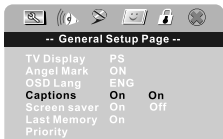

Closed Caption On

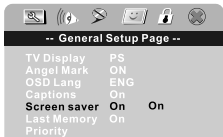

Screen Saver

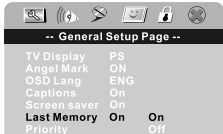

Set Last Memory State



2. Audio Setup Page

According to the operation of DVD System Setup Page, select what you prefer.

3. Video Quality Setup Page

The customer can carry on correspond according to the actual display quality the operation of the bright, contrast, Gamma, and is as follows : To choose among them a certain (such as the contrast degree), press to confirm the key in to regulate the menu. Pass left, right to choose among them a certain (such as the contrast), press Enter key to regulate the menu. Pass left, the right can carry on gradually decrease toward key or increased function, press Enter key to then return the upper level menu again.

4. Set Preference Page

Note : At is in the stop stage or machine inside have no disc, press setup key to enter to preference page, is shown as diagram above.

(1) Set TV Standard

If the TV type is for PAL, Please choose the PAL.
If the TV type is for AUTO, please choose the Multi.
If the TV type is for NTSC, please choose the NTSC.

(2) Set PBC state

On : Open the manifestation of the disc song menu (Only the ability selects songs in the song menu appearance). While winning an election to choose to open(the song menu), pass [TITLE] the key can return the song menu.

Off : Close the manifestation of the disc catalogue menu(can press numerical key to carry on the selected songs directly).

(3) Parental

Target the function, can pass` the age control` to play to match the disc of the age grade, and match with the control with password.

This secret code is : 123456

(4) Default

If you do not want to reserve the oneself's parameter for various enactment of the function, choose reset to default, DVD machine will instauration a factory original.

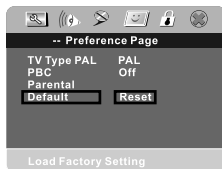
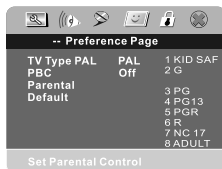
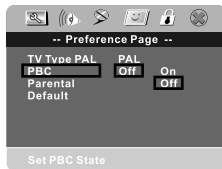
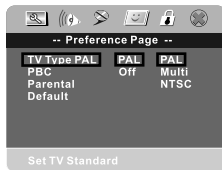
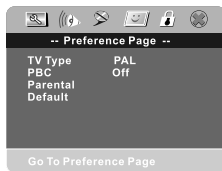

5. Password Setup Page



Password Mode : To select password Mode

Password : To change password

While winning an election to settle the password options, press rightwards the direction key, at the cursor is order bright, press "Enter" key in to reorganize the password menu, input the old password 123456, choose the cursor to move to the new password, after inputting the password and confirming the password at this time, press to "Play" or "Enter" key.

Note : This secret code is 123456, if you forget the password, this password is always valid.

About Program

Pressing contents in the disc the sequence that you need carries on weaving the distance, the machine play the sequence that you arrange in order automatically.

Note : The MP3 disc can't carry on weaving the distance to play . (When play MP3 disc, press the program key is to use to choose "catalogue play" or "file list play", which is two kinds of play mode.)

Basic Operation For Playing DVD

We will introduce some regular operations of different types of function, the user can perform one or more operations as you like.

- Select part to be played with menu

If DVD disc to be played has menu, when PBC state is on, you can display the menu by pushing [MENU] or [TITLE], when you select a popular part to play, you can operate following procedures.

1. Push [Menu] the screen display menu picture, the content to be selected varies with different disc.
2. Push [▲] [▼] [◀] [▶] move the lighting band to the desired item or made by pushing these buttons.
3. Push [Enter] to confirm selecting the item. This moment the screen may display a submenu, you can also push [▲] [▼] [◀] [▶] to select, push [Enter] to confirm the selection.

- Play fast forward

While playing you can push [FF] button to play fast forward. Four speeds (2X,4X, 8X, 16X, 32X) are available to play forward, press it once the speed grows by one shift, when the speed reaches maximum speed, press [FF] again to return to normal state.

- Play fast backward

While playing you can push [FB] button to play fast backward. Four speed are available to play forward, press it once the speed grows by one shift, when the speed reaches maximum speed, press [FB] again to return to normal state.

- Slow play

While playing, push [SLOW] to play slowly for only DVD disc at different speed. You can play slow forward or backward, three shift speed are available for either of them. Push [SLOW] once, press it once the speed decreases by one shift, finally it returns to normal state.

- Skip to next chapter / track

While playing push [▶▶] button.

- Skip to previous chapter / track

While playing push [◀◀] button.

- Select track

There are more than one operation procedure available.

1. Push [◀◀] or [▶▶] to skip to the next or the previous track and play.
2. For those disc with track numbered directly push number buttons to enter the No. of desired track to play. If the moment the screen display, so there may be three possible reasons:

- A. The track in the disc is not numbered.
- B. The number entered beyond the scope.
- C. Select among the song track list (refer to the next chapter).

- Display the track list

For DVD disc, when PBC is on, push [MENU] to display the track list, the moment firstly push [~]/[~] to select a track then push [Enter] to play. For non-DVD disc, when PBC is on, while playing push [RESUME] to display the track list, the moment you can directly enter number to select. You can push [PBC] to change PBC state.

Attention : whether the above procedures work will be subject to the type of disc.

Other Operation

- Mute

1. Push MUTE button on the front panel or the remoter control to shut off the sound output.
2. Push it again to resume to previous volume level. Turn the volume button also can cancel the mute function.

- Audio control

1. Push the [VOL+] button to increase sound level.
Push the [VOL -] button to decrease sound level.

- Audio channel

Push the [AUDIO] button on the remoter control to change the audio channel in the DVD mode.

Rear Panel

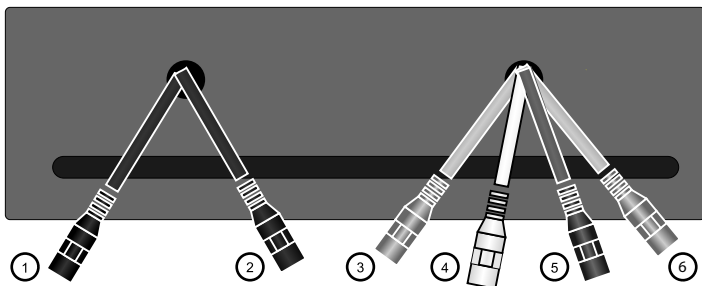

① Remote Sensor Connector

③ Video Out 1 (Yellow)

⑤ Audio-R (Red)

② DC 12V In

④ Audio-L (White)

⑥ Video Out 2 (Yellow)

Accessories

Power cord



Battery

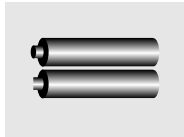

Screws

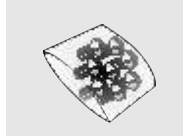

L-bracket

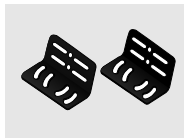

Remote Control

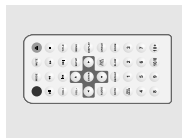

Specification

S/N	
Cross talk	85 dBA
Distortion	75 dBA
Freq. Range	60 dB
Output level	10-20, 000Hz +/- 1 dB
	2V +/- 0.2V
<i>Video</i>	
Output level	1V p_p +/- 0.2V
Resolution	>=500TV line
<i>General</i>	
Output	Line Output
	Video Output
Tone Control	Bass + 7dB (100Hz)
	Treble ± 7dB (10KHz)
Power Requirement	12V DC

Note : Due to continuous product improvement, specification and design are subject to change without notice.

under SEAT (rear operate)

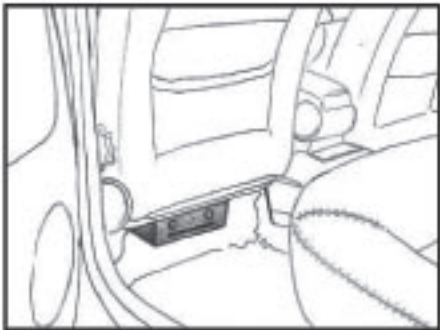

under SEAT (front operate)

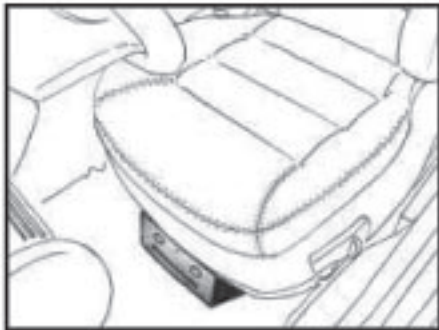

in GLOVE BOX



inside CONSOLE

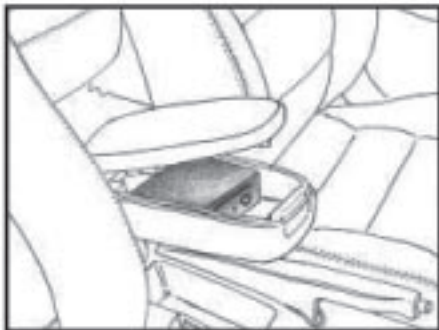

in the TRUNK

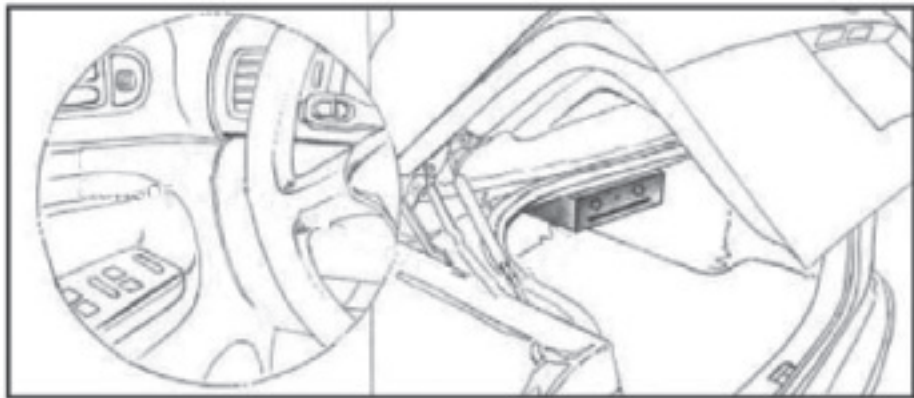

under GLOVE BOX



WARRANTY

ONE (1) YEAR LIMITED WARRANTY

Magnadyne Corporation or its authorized agents will within one year from the date of sale to you, repair, replace or refund the retail sales price of said product or any part thereof, at the option of the Magnadyne Corporation or its authorized agents, if said product or part is found defective in materials or workmanship, when properly connected and operating on the correct power requirements designated for the specific product. This warranty and Magnadyne Corporation or its authorized agent's obligations hereunder do not apply where the product was; damaged while in the possession of the consumer, subjected to unreasonable or unintended use, not reasonably maintained, utilized in commercial or industrial operations, or serviced by anyone other than Magnadyne Corporation or its authorized agents, or where the warning seal on the product is broken or the power and/or plugs are detached from the unit. Magnadyne Corporation or any of its authorized agents will not assume any labor costs for the removal and reinstallation of any product found to be defective, or the cost of transportation to Magnadyne Corporation or its authorized agents. Such cost are the sole responsibility of the purchaser.

This warranty does not cover the cabinet appearance items or accessories used in connection with this product, or any damage to recording or recording tape, or any damage to the products resulting from improper installation, alteration, accident, misuse, abuse or acts of nature.

MAGNADYNE CORPORATION OR ITS AUTHORIZED AGENTS SHALL NOT BE LIABLE TO ANYONE FOR CONSEQUENTIAL OR INCIDENTAL DAMAGES OR CLAIMS EXCEPT THOSE ACCORDED BY LAW. NO EXPRESSED WARRANTY OR IMPLIED WARRANTY IS GIVEN EXCEPT THOSE SET FORTH HEREIN. NO IMPLIED WARRANTY SHALL EXTEND BEYOND ONE YEAE FROM THE DATE OF SALE.

This warranty extends only to the original purchaser of the product and is not transferable. Some states do not allow limitations on how long an implied warranty lasts, and some states do not allow the exclusion or limitation of incidental or consequential damages, so the above limitations or exclusion may not apply to you. This warranty gives you specific legal rights, and you may have other rights that vary from state to state.

"NOTE: The manufacturer is not responsible for any radio or TV interference caused by unauthorized modifications to this equipment. Such modifications could void the User's authority to operate the equipment."

Defective merchandise should be returned to the original point of purchase or secondly, to Magnadyne Corporation, 1111 W. Victoria Street, Compton CA 90220. Return Authorization must be obtained before sending, or merchandise may be refused.